



Continuous Cleat Plus

Intermittent Clip with a Continuous Cleat.

ORDER SPECIFICATION FORM

ANSI/SPRI/FM4435/ES-1 TEST PRESSURES UP TO 159 PSF(VERTICAL) , AND 91 PSF (HORIZONTAL)

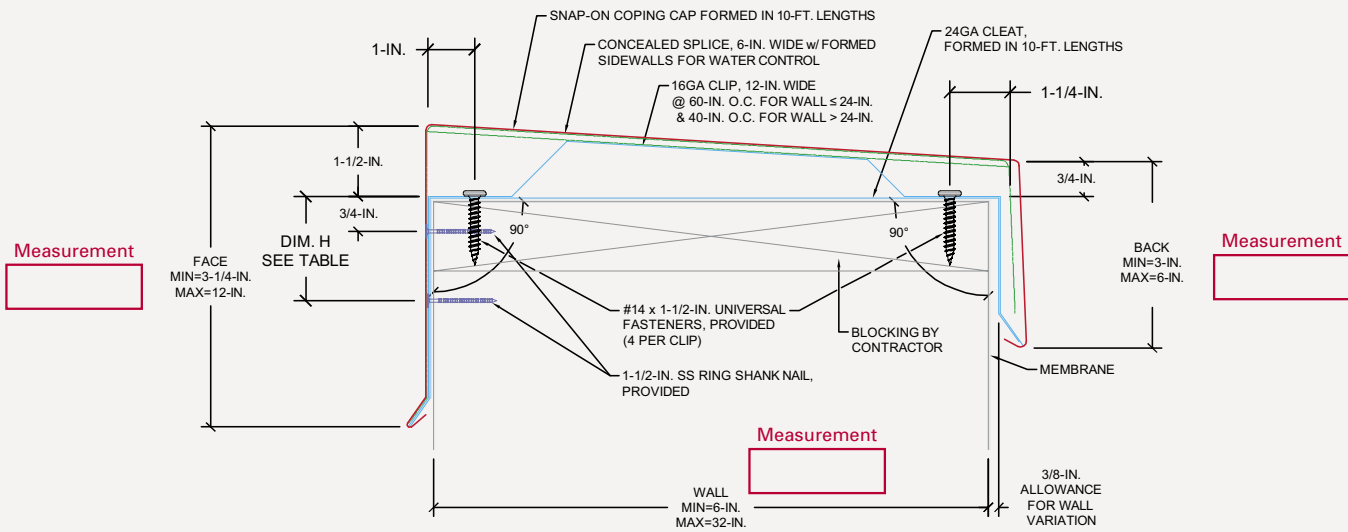

FACE SIZE	DIM. H
FACE < 4-3/4-IN.	3/4-IN.
4-3/4-IN. ≤ FACE ≤ 7-1/2-IN.	2-1/4-IN.
7-1/2-IN. < FACE ≤ 9-IN.	3-3/4-IN.
9-IN. < FACE ≤ 10-1/2-IN.	5-1/4-IN.
10-1/2-IN. < FACE ≤ 12-IN.	6-3/4-IN.

FOR MASONRY APPLICATIONS, PLEASE CONTACT US.
CONTACT US FOR APPROPRIATE RECOMMENDATIONS NEEDED TO MEET/EXCEED
ANSI/SPRI/FM4435/ES-1 DESIGN CRITERIA

APPROVALS	COVER MATERIAL	THICKNESS	COVER FINISH
ANSI/SPRI/FM 4435 /ES-1 TESTED Florida Product Approval MIAMI-DADE COUNTY APPROVED CLASSIFIED UL	minium Galvanized Steel Stainless Steel	24Ga. 22Ga. .040 in. .050 in. .063 in. .080 in.	Mill Prefinished Kynar Premium Prefinished Kynar Post Finished Kynar Prefinished Anodized Post Finished Anodized
QUANTITY Attach Sketches of Z- and T- Miters _____ Straight Length _____ Total Miters (Inside: _____ / Outside: _____) _____ Total End Caps (Left: _____ / Right: _____) _____ Total End Terms (Left: _____ / Right: _____) _____ Transition Miters _____ T-Miter _____ Z-Miter _____ Radius _____ Radius to Straight Miter _____ Radius End Cap _____ Vault Welded _____ Vault to Straight Miter Welded _____ Vault End Cap _____ Ridge Miter _____ Valley Miter	ACCESSORY TYPE Welded Metal-Lok	CUSTOMER APPROVAL Approved for Fabrication Approved with Changes Not Approved _____ Authorized Customer Signature Title _____ Date _____	
COLOR _____	Job Name: Project Location: Customer: Representative:		



Continuous Cleat Plus

Intermittent Clip with a Continuous Cleat.

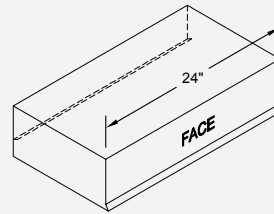
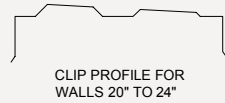
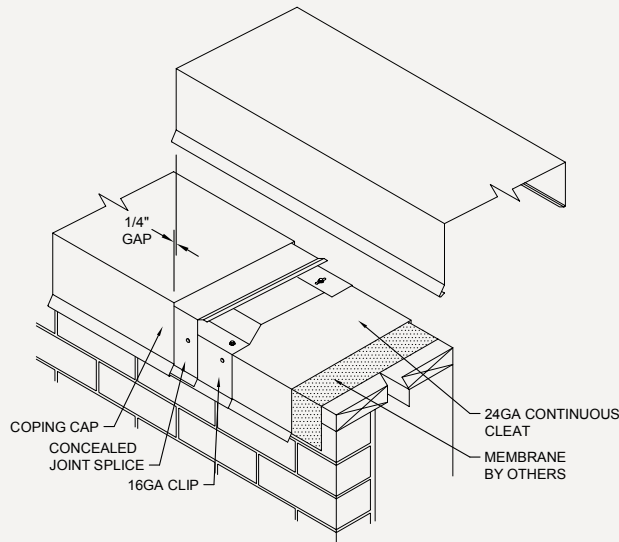

END CAP
LEFT HAND SHOWN

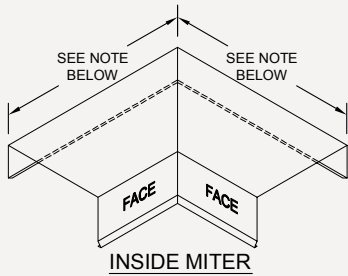

INSIDE MITER

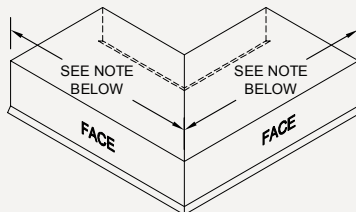

OUTSIDE MITER

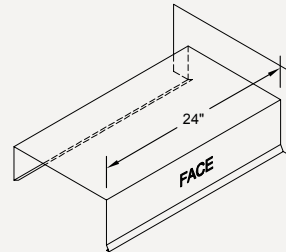

END TERM
RIGHT HAND SHOWN

Standard coping miter leg lengths:
 23 1/4-in. for 7 1/2-in. to 16-in. wall widths
 29 1/4-in. 16-in. to 23-in. wall widths
 custom lengths for wall widths > 23-in.
 Standard coping miter angle is 90°
 For special miter requirements, attach sketches or consult manufacturer for assistance.



EdgeSystems

4 COMMERCE WAY, ARDEN NC 28704 USA
 800-892-9173 828-676-1700 OMGROOFING.COM

Copyright © 2020 OMG, Inc. All rights reserved.

Superior productivity.
 Superior performance.

